



SMOKER

For Outdoor Use
Model # 24S-SM(B)

INSTALLATION INSTRUCTIONS AND OWNER'S MANUAL

INSTALLER: Leave these instructions with consumer.
CONSUMER: Retain for future reference.



IMPORTANT: READ THESE INSTRUCTIONS CAREFULLY BEFORE STARTING INSTALLATION OR USE.

WARNINGS AND SAFETY CODES

⚠ WARNING
Do not store or use gasoline or other flammable vapors and liquids, including propane cylinders, in the vicinity of this or any other appliance.

⚠ WARNING
Improper assembly, adjustment, alteration, service, or maintenance can cause injury or property damage. Refer to this manual. For assistance or additional information, consult a qualified professional installer, or service agency.

CODE REQUIREMENTS: This smoker must be operated in accordance with any local codes and ordinances.

WARNING: All surfaces of the smoker become **HOT** during use. Exercise caution at all times when this unit is in operation.

FAILURE TO FOLLOW THE INFORMATION IN THIS MANUAL MAY RESULT IN BODILY INJURY AND/OR PROPER DAMAGE.

CONTENTS

3	IMPORTANT PRE-OPERATION AND SAFETY INFORMATION
4	REPLACEMENT PARTS LIST
5	SPECIFICATIONS
6	CHIMNEYS
6	DRIP COLLECTOR & TRAY
6	ASSEMBLY
7	COOKING GRIDS
7	ASH COMPARTMENT
8	PRE-OPERATION / LOCATION NOTES
8	PREPARATION FOR USE
9	LIGHTING
9	OPERATION GUIDELINES
10	PRE-HEATING, SMOKING START-UP & LOADING
12	COOKING
13	DIGITAL THERMOMETER
13	DEFAULT SCREEN
14	MENU SCREEN
16	ADDING ADDITIONAL CHARCOAL / WOOD CHIPS DURING COOKING
16	OVERHEATING
16	OPERATION SUMMARY
17	SMOKING TIMES AND TEMPERATURES
17	POST-OPERATION
18	INTERIOR CLEANING
18	STAINLESS STEEL CARE
18	REPLACING THERMOMETER BATTERIES
18	SERVICING AND CLEANING
19	ACCESSORY DRAWER (OPTIONAL)
19	ACCESSORIES
20	NOTES PAGE
21	TROUBLESHOOTING
22	WARRANTY

IMPORTANT PRE-OPERATION AND SAFETY INFORMATION



WARNING!

1. **Read all instructions.**
2. This unit is designed **FOR OUTDOOR USE ONLY. DO NOT use this unit under unprotected flammable surfaces. DO NOT use this appliance inside a building, garage, or any other enclosed area.**
3. For household use only. Do not use this unit for purposes other than intended.
4. Only use this unit on a hard, level, non-combustible, surface capable of supporting the unit's weight.
5. Use caution when lifting or moving the unit to prevent personal injury, or damage to the unit. Moving the unit may require the help of additional people.
6. Prior to initial use; the unit must be wiped down and cured as instructed in this manual.
7. It is recommended that a fire extinguisher be placed near the unit. Refer to your local authority for size and type detail.
8. Due to high temperatures, the unit must be located and operated out of traffic areas and away from combustibles.
9. Maintain a 10 foot clearance between the unit and combustible material when in use.
10. Do not move the unit when in use.
11. **Children MUST be carefully supervised when they are in the area of this unit.**
12. **DO NOT sit or place any part of the body, clothing, or other flammable materials on or near the unit surround. Children and adults should be alerted to the hazard of high surface temperatures and should stay away to avoid burns or clothing ignition.**
13. **All surfaces of the smoker may become HOT during use. Exercise caution at all times when this unit is in operation.**
14. Never operate this unit without the drip collector and drip tray in place. **DO NOT allow grease to build up at the bottom of the smoker. This may result in a grease fire! Clean all grease out after each use.**
15. To avoid burns when cooking, wear (dry) protective gloves or oven mitts and use long handled BBQ tools. When opening a door; open slowly to carefully allow heat and steam to escape. Use caution and keep hands, face, and body at a safe distance.
16. Do not wear loose clothing or allow hair to come in contact with the unit.
17. During use in windy weather; the rain caps may be adjusted and/or the unit may be rotated if the wind disrupts the temperature/cook.
18. Carefully follow the operation and post-operation instructions in this manual.
19. Never leave coals and ashes in the unit unattended. Dispose of them properly as instructed in this manual.
20. Clean your smoker thoroughly after each use.
21. Before storing; make sure the unit is completely cool. Store it out of reach of children, in a well ventilated, dry place.

SAVE THESE INSTRUCTIONS

REPLACEMENT PARTS LIST

Item	Description	24S-SM		24S-SMB	
		Part No.	Qty.	Part No.	Qty.
1.	Smoker door assembly	23311	1	23311	1
2.	Digital thermometer	24180-12	1	24180-12	1
3.	Chimney assembly	23312	2	23312	2
4.	Firebox door	23313	1	23313	1
5.	Ash compartment door	23314	1	23314	1
6.	Cooking grid	3553	5	3553	5
7.	Drip collector	23315	1	23315	1
8.	Drip tray	23316	1	23316	1
9.	Wood pellet screen	23317	1	23317	1
10.	Wood chip grid	23318	1	23318	1
11.	Charcoal grid	23319	1	23319	1
12.	Ash tray	23320	1	23320	1
13.	Complete base drawer assembly	n/a	1	24-SMB	1
14.	Base drawer (only)	n/a	1	23321	1

Replacement parts can be ordered from your local Fire Magic® dealer.

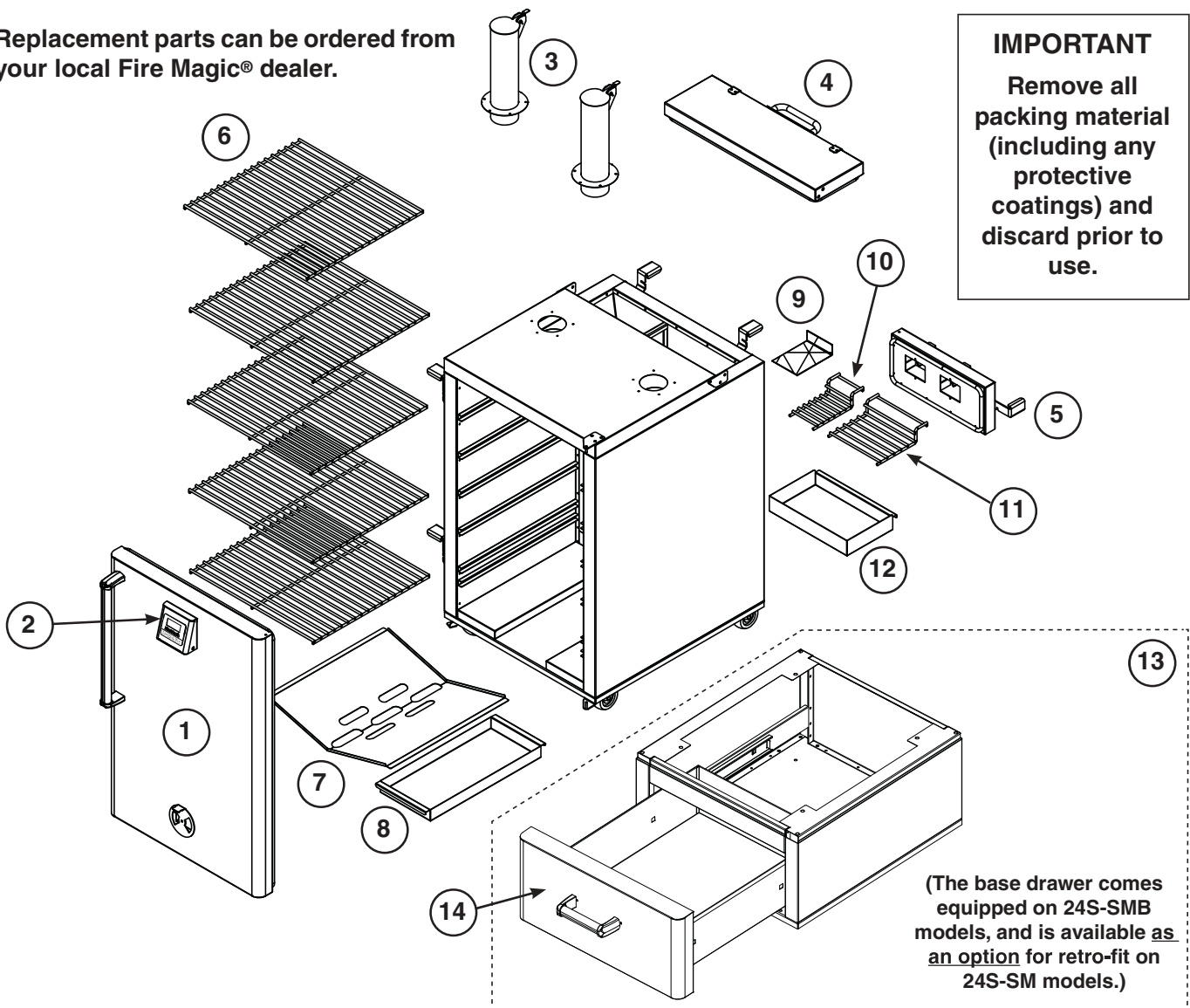

IMPORTANT
Remove all packing material (including any protective coatings) and discard prior to use.

(The base drawer comes equipped on 24S-SMB models, and is available as an option for retro-fit on 24S-SM models.)

SPECIFICATIONS

Specification	24S-SM Value	24S-SMB Value
Overall height	47 1/2"	60"
Overall width	26"	26"
Overall depth	35 1/2"	35 1/2"

Specification	Value
Temperature range	0 - 450°F
Cooking area	1640 sq. in. (5 - 17 1/2" x 18 3/4" grids)
Cooking capacity	6 cubic feet
Electrical requirement (for thermometer)	3v (2 x AA batteries)
Unit weight	24S-SM: 245 lbs / 24S-SMB: 290 lbs
Other	Constructed of 100% stainless steel with 2" of insulation

Table 1 - Specifications Table

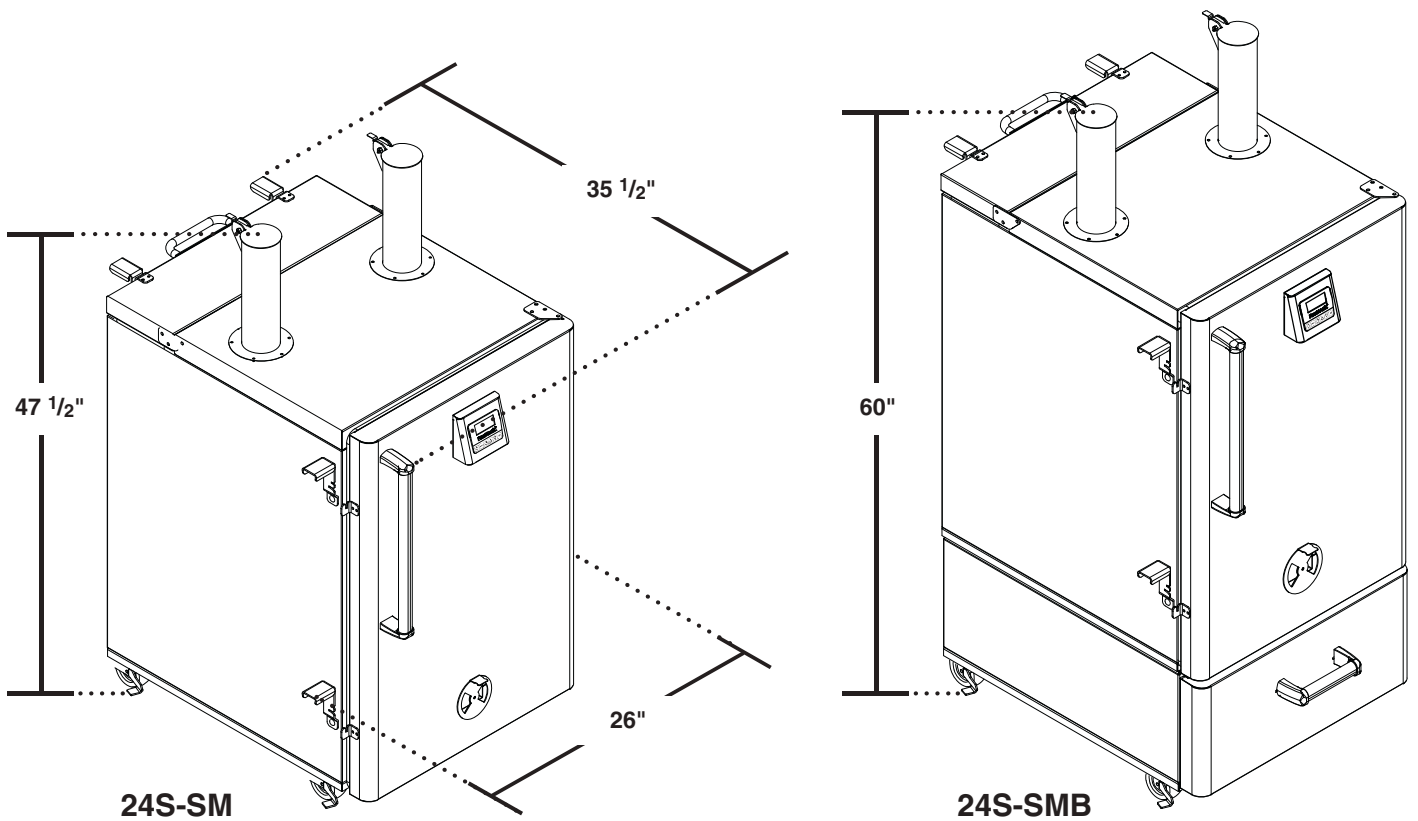

Fig. 5-1 - Overall dimensions diagram

ASSEMBLY

This smoker comes shipped with accessories and components packaged inside of it. Remove these items and discard all packaging.

PRIOR TO ASSEMBLING; use a damp cloth to completely wipe down all of the items, and the interior compartments of the smoker. This will remove any loose debris that may have built up during the manufacturing process.

REFER TO THE PARTS LIST WHEN FOLLOWING THESE INSTRUCTIONS.

CHIMNEYS

1. Locate a chimney assembly.
2. Orient it over one of the large holes found on the top of the smoker. Line up all screw holes of the chimney over the screw holes found on the smoker.
3. Hand tighten 5 of the supplied screws in place, being sure that the chimney is properly aligned. Then use a Phillips screwdriver to completely fasten. See Fig. 6-1.
4. Repeat for the second chimney assembly.

DRIP COLLECTOR & TRAY

1. Locate the drip collector and drip tray.
2. Unlatch and open the smoker door.
3. Place the drip tray inside the unit, at the very bottom. Slide it into place as shown in Fig. 6-2. Be sure it completely slides in.
4. Slide the drip collector into place, just above the drip tray. See Fig. 6-3. Be sure it completely slides in.



Fig. 6-1



Fig. 6-2



Fig. 6-3

ASSEMBLY (cont.)

COOKING GRIDS

1. Slide each cooking grid into place as desired. Be sure that the cooking grid properly enters the grid supports and completely slides in. See Fig. 7-1.

Note: Cooking grids may be added / removed as desired depending on the sizes of the food loaded into the smoker.

ASH COMPARTMENT

1. Locate the ash tray, charcoal grid, wood chip grid, and wood pellet screen.
2. Open the ash compartment door located on the rear of the smoker.
3. Slide the ash tray into the bottom of the compartment. See Fig 7-2.
4. Place the charcoal grid on the left side of the compartment. Place the wood chip grid on the right side of the compartment. See Fig. 7-3.
5. The wood pellet screen is only used when wood pellets are used for smoking. They are smaller in size (than the standard wood chips) and need the screen to prevent them from falling through the standard grid. The screen simply rests on top of the wood chip grid as shown in Fig. 7-4.

Note: Store the wood pellet screen in a designated location outside of the smoker when not required for use.



Fig. 7-1

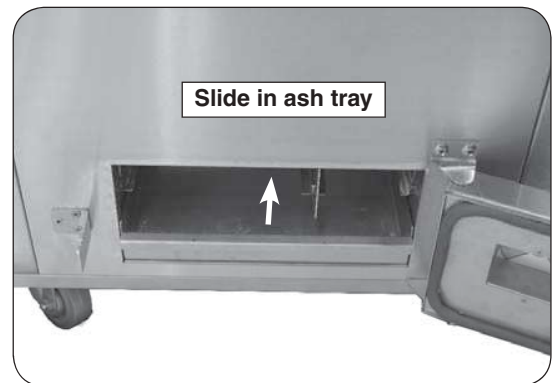

Fig. 7-2

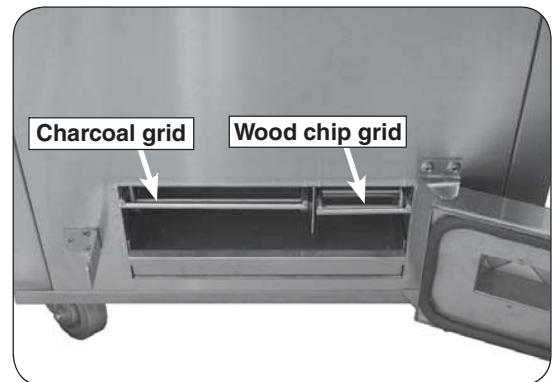

Fig. 7-3

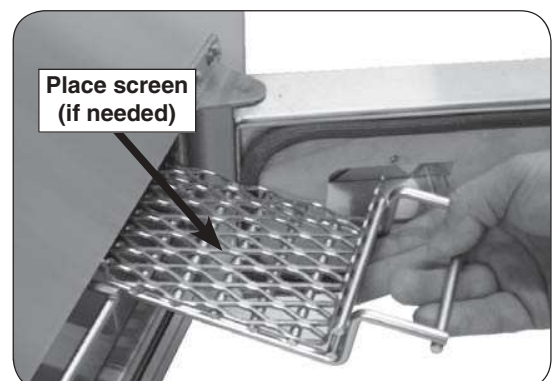

Fig. 7-4

PREPARATION FOR USE

Important: Prior to initial use; the smoker interior **MUST** be wiped down (as instructed in the previous **ASSEMBLY** section) and cured. Curing the smoker helps to protect the finish, and remove any smoker smells that may affect the first meal cooked. See below for curing details.

1. Unlatch and open the smoker door.
2. Lightly coat all of the interior surfaces of the smoker (including the grids, collector & tray) with vegetable oil or vegetable spray.
3. Carefully follow the **OPERATION GUIDELINES** section to light your smoker. However, only burn with charcoal for heat purposes, and only insert as much charcoal necessary for the curing process (approximately 3 hours).

Important: **DO NOT LOAD THE SMOKER WITH ANY FOOD DURING THE CURING PROCESS.**

4. Allow the smoker to reach 250°F. Continue to burn for 2 hours thereafter. After the burn is complete, allow the unit to completely cool.
5. Carefully follow the **POST-OPERATION** section for charcoal removal and smoker cleaning.

YOUR SMOKER IS NOW READY FOR USE.



Fig. 8-1

PRE-OPERATION / LOCATION NOTES

Important: **BE SURE TO READ AND ABIDE BY ALL SAFETY WARNINGS AND INSTRUCTIONS IN THIS MANUAL PRIOR TO OPERATION.**

- This unit is designed **FOR OUTDOOR USE ONLY. DO NOT use this unit under unprotected flammable surfaces. DO NOT use this appliance inside a building, garage, or any other enclosed area.**
- Only use this unit on a hard, level, non-combustible, surface capable of supporting the unit's weight.
- Due to high temperatures, the unit must be located and operated out of traffic areas and away from combustibles.
- Maintain a 10 foot clearance between the unit and combustible material when in use.
- During use in windy weather; the rain caps may be adjusted and/or the unit may be rotated if the wind disrupts the temperature/cook.
- Place the smoker in an area that is away from any open doors or windows to prevent smoke from entering into your home.
- **Orient the cooking grids as desired to accommodate the food to be cooked. DO THIS PRIOR TO OPERATION TO PREVENT ANY UNNECESSARY HEAT LOSS DURING COOKING.**

Only open the front smoker door when instructed during the pre-heating stage. During the cooking stages, try to limit the amount of times any doors are opened. Each time a door is opened; heat loss occurs, resulting in longer periods of time to bring the smoker up to temperature and longer cooking times.

OPERATION GUIDELINES

The following sections cover the basic guidelines for lighting and using your smoker. Cooking temperatures, times, and methods may vary depending on personal preference, weather conditions, etc. **DO NOT LEAVE THE UNIT UNATTENDED WHEN IN USE.**

LIGHTING

1. Unlatch and open the firebox door located on the top rear of the smoker (see Fig. 9-1).

The larger chamber on the left is for loading charcoal. The smaller chamber on the right is for loading wood chips.

Note: Both chambers may be loaded with charcoal when smoking is not desired. This will achieve higher temperatures, in a quicker time period. This is also recommended when the smoker is being cured.

2. Fully open the rain caps on the two chimneys, located at the top of the smoker (reference Fig. 9-1).
3. Drop crumpled newspaper balls into the charcoal chamber until the chamber bottom is completely covered and full. This will take approximately 6 pieces of newspaper.
4. Pour 2-5 pounds of charcoal into the charcoal chamber, directly above the crumpled newspaper. (Approximately 2 lbs of charcoal for every 15 lbs of meat to be cooked. This will maintain approximately a 225° temp. Adjust accordingly.) **THIS INITIAL AMOUNT IS TO GET THE SMOKER LIT AND UP TO TEMPERATURE. ADDITIONAL CHARCOAL IS TO BE ADDED IN THE FOLLOWING SECTION.**

CAUTION: DO NOT add more than 5 lbs of charcoal when pre-heating. This will cause rapid heating and may cause damage to the unit.

5. Unlatch and open the ash compartment door located on the bottom rear of the smoker (see Fig. 9-2).
6. Use a lighter or long match to light the newspaper through the ash compartment. The flame should easily rise up through the charcoal grid and ignite the paper (see Fig. 9-2).
7. Leave both the firebox door and ash compartment door completely open during the charcoal lighting process. This will allow for adequate air circulation to assist in the light.

Note: NEVER ADD ANY TYPE OF LIGHTING FLUID TO THE CHARCOAL CHAMBER ONCE THE CHARCOAL IS LIT. THIS WILL CAUSE A DANGEROUS FLASHBACK.

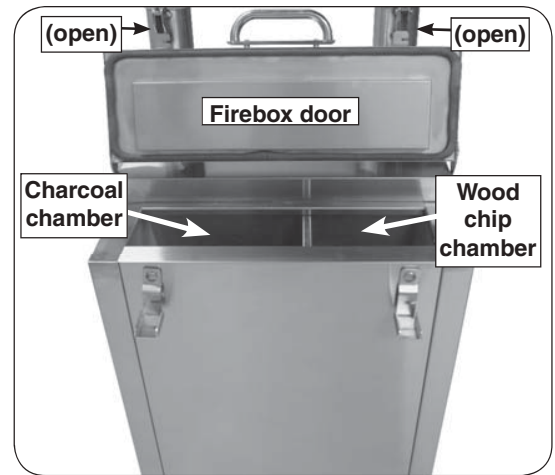

Fig. 9-1

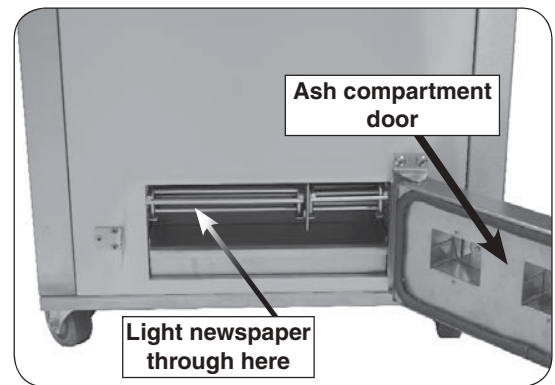

Fig. 9-2

OPERATION GUIDELINES (cont.)

8. Allow all of the charcoal to fully ignite. **Once the flame dies down and the charcoal begins to glow red; move on to the following section.**

ALTERNATE LIGHTING: This smoker was designed for this newspaper lighting method. However, a charcoal chimney starter may be used if desired. Follow the instructions supplied with the chimney starter. Once the charcoal in the chimney starter is burning steadily and begins to ash over, carefully pour it down into the charcoal chamber. Add additional charcoal to the chamber for a total of 2-5 pounds. Then refer back to steps # 7 and #8.

PRE-HEATING, SMOKING START-UP & LOADING

1. **Once the charcoal is glowing red**, pour approximately 1 pound of wood chips into the wood chip chamber. (The wood chips may be pre-soaked in water if desired.)

Note: If using wood pellets, the wood pellet screen must first be installed over the wood chip grid (see assembly section and Fig. 7-4 for details). The screen prevents the pellets from falling down into the ash tray.

2. Close and latch both the firebox door and the ash compartment door. Completely open the two air shutters on the ash door (see Fig. 10-1).
3. Unlatch and open the front smoker door.
4. Carefully fill the drip tray with water or a liquid flavoring of your choice. (Hot water is recommended.)

Note: Although not required; it is recommended that an additional pan filled with liquid be placed on the rear of the bottom rack. The pan **MUST** be oven safe. A 1/2 gallon of water is sufficient.

5. Using (dry) protective gloves or oven mitts and long handled BBQ tools; load the food to be cooked. Slightly pulling out the grids (with gloves) will allow for easier loading. Proper spacing between the food will allow for adequate air flow and an optimal smoke. See Fig. 10-2.
6. Close and latch the smoker door. Be sure the air shutters on the front door are closed (see Fig. 10-3).
7. Allow the smoker to pre-heat until the desired cooking temperature is reached. Smoking temperatures range between 175°F & 250°F. Turn the thermometer on to view the current smoker internal temperature (see Fig. 10-4). (See the DIGITAL THERMOMETER section for complete use.)

BE PATIENT AS THE AMOUNT OF TIME REQUIRED BEFORE YOUR SMOKER IS UP TO TEMPERATURE WILL BE AFFECTED BY MANY VARIABLES (WEATHER CONDITIONS, AMOUNT OF FOOD LOADED, CHARCOAL TYPE AND AMOUNT USED, ETC.)

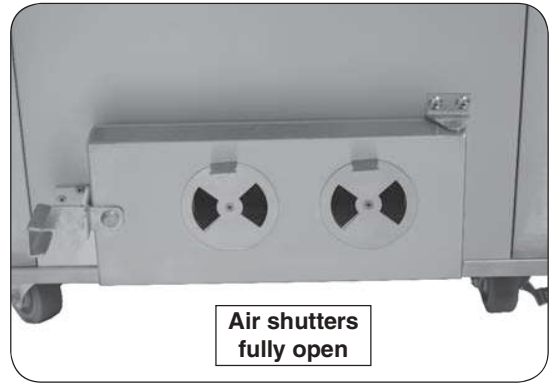

Fig. 10-1

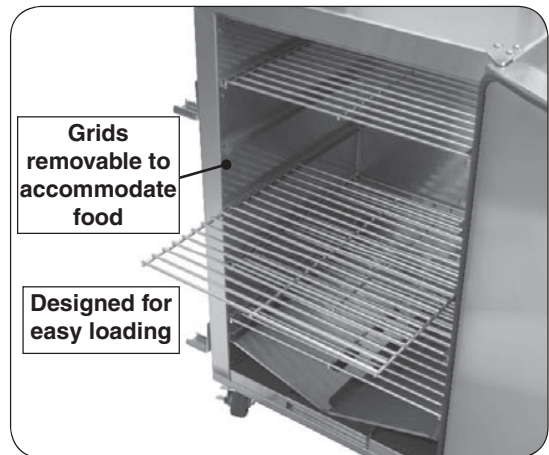

Fig. 10-2



Fig. 10-3



Fig. 10-4

OPERATION GUIDELINES (cont.)

8. Once the desired temperature is reached; adjust the two air shutters on the ash door to an approximate $\frac{1}{8}$ " (see Fig. 11-1).
9. At this stage, additional charcoal required for the cook must **CAREFULLY** be added to the charcoal chamber. (Approximately 2 lbs of charcoal for every 15 lbs of meat to be cooked. This is based on a 6 hour cook. Adjust accordingly.) For large amounts of meat, charcoal may be added throughout the cooking period.

CAUTION: OPENING THE FIREBOX DOOR WILL INTRODUCE A FLOW OF OXYGEN TO THE CHARCOAL AND MAY CAUSE A FLARE-UP! When opening the door; open slowly to carefully allow heat and steam to escape. Use caution and keep hands, face, and body at a safe distance.

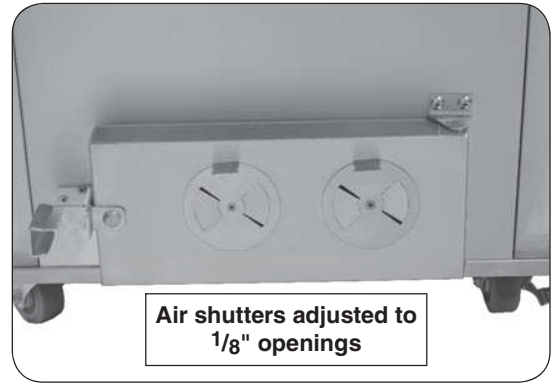

Fig. 11-1

OPERATION GUIDELINES (cont.)

COOKING

All surfaces of the smoker may become HOT during use. Exercise caution at all times when this unit is in operation. To avoid burns when cooking, wear (dry) protective gloves or oven mitts and use long handled BBQ tools. When opening a door; open slowly to carefully allow heat and steam to escape. Use caution and keep hands, face, and body at a safe distance.

Important: Be prepared when opening the smoker. When the smoker door is opened, heat is lost, and the temperature will continue to drop as long as the door is open. Try to limit the amount of times the door is opened.

Certain areas of the smoker will achieve a higher temperature when cooking. (The digital thermometer takes an average temperature reading.)

During cooking the desired temperature may be maintained by keeping the **ash door air shutters** at approximately an 1/8" opening. They may be adjusted as needed throughout the cook to control the temperature.

- To increase the temperature; fully open the **ash door air shutters**.
- To decrease the temperature; fully close the **ash door air shutters**. (If the **ash door air shutters** are left closed for too long a period; the fire may completely turn out.)
- The chimneys can be adjusted during operation, based on weather conditions. During rain or extremely windy conditions; the rain caps may be partially/fully closed.

Note: The **front door air shutter** is to remain closed during cooking. It was designed to be opened only when necessary to DECREASE the cooking temperature. Re-close it once the desired temperature is achieved.

Cook accordingly. A chart is provided in the SMOKING TIMES AND TEMPERATURE section for suggestions. These are approximations and may vary.

REFER TO THE DIGITAL THERMOMETER SECTION FOR DETAILS ON MONITORING THE SMOKER TEMPERATURE AND MEAT PROBE USE.



Fig. 12-1

DIGITAL THERMOMETER

Your smoker comes with a digital thermometer for oven and meat probe temperature monitoring, and timed cooking. Pressing the power button will turn on the thermometer. The thermometer will automatically shut off after 5 minutes if no temperature change is detected.

The thermometer is located on the front smoker door.

The thermometer provides an overall, average temperature reading. The temperature will be higher toward the top and rear of the unit, and lower toward the bottom and front of the unit.

FOR BEST PERFORMANCE, GENTLY PRESS THE BUTTONS. When turned on, accurate temperature readings will begin after the thermometer has initialized. When turned off, allow 5 seconds prior to turning back on.

Read the following sections completely regarding thermometer operation. Refer to Fig. 13-1 for thermometer orientation and button locations.

DEFAULT SCREEN

Press the power button to turn the thermometer ON. The default screen will be displayed. Temperatures for the oven and meat probe will be shown (Fig. 13-2). See below for options under the default screen.

Setting a Location Temperature

1. Press the up/down arrow to switch to the desired location (oven or meat probe). Location will be highlighted when selected. Press **SET**.
2. The selected location's temperature screen will be displayed. Use the arrows to set the desired temp. The actual temp. will also be shown. (See Fig. 13-3)

Note: PRESSING the arrows will adjust the desired temp. by increments of one degree. HOLDING them down (for several seconds) will adjust the temp. rapidly.

3. Press **SET** to return to the default screen. Repeat as necessary for other location.

The display will flash red and the alarm will sound (if set to do so) when the oven / meat probe reaches its set temperature. The alarm is silenced by pressing any button on the thermometer.

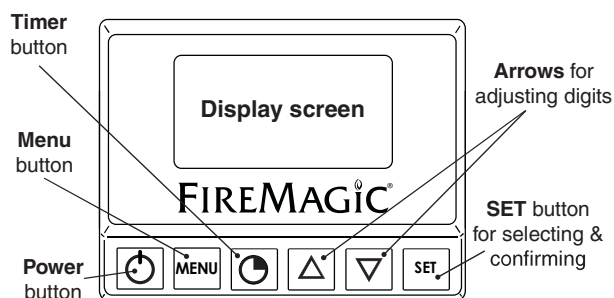

Fig. 13-1 Orientation

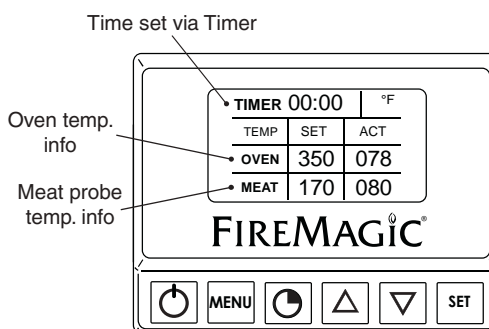

Fig. 13-2 Default screen detail

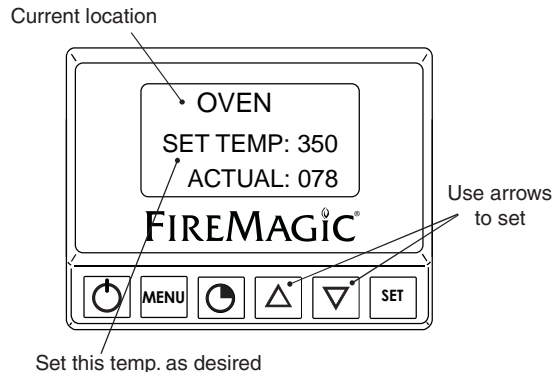

Fig. 13-3 Location temp. screen (oven shown)

DIGITAL THERMOMETER (cont.)

Setting the Timer

1. Press the timer button. Use the arrows to set the desired amount of time (see Fig. 14-1.)
2. Press **SET** to return to the default screen.

The time remaining will be shown on the default screen. Once the time reaches zero; the display will flash red and the alarm will sound. The alarm is silenced by pressing any button on the thermometer.

MENU SCREEN

Press the **power** button to turn the thermometer **ON**. The default screen will be displayed. Press the **MENU** button to display its screen. Press the up/down arrow to scroll through the options. (See Fig. 14-2.) See below for options under the menu screen.

Note: The menu screen will return to the default screen after approximately 30 seconds of no activity. Press the **MENU** button to manually return to the default screen.

Changing temperature units (°C/°F)

1. Under the menu screen select **SETUP**. Press **SET**.
2. Press the up/down arrow to select **SETUP FC**. Press **SET**.
3. Press the up/down arrow to select the desired temperature unit (°C/°F).
4. Press **SET** to return to the menu screen.

Grill Guide and Meat Probe

The grill guide displays recommended ready temperatures for various meats.

Plug the meat probe as shown in Fig. 14-3. **Carefully** run the wire (use protective gloves) behind the smoker door. This will allow for the door to be closed while the meat probe is inserted into food inside of the smoker.

The meat probe is designed to be left in the food with the door closed in average “smoking” temperatures. DO NOT leave the meat probe inside of the smoker when temperatures exceed 350°F.

1. Under the menu screen select **GRILL GUIDE**. Press **SET**.
2. Press the up/down arrow to view the desired meat.
3. Note the temp. and press **SET**. This will take you to the meat probe temperature screen.
4. Use the arrows to set the noted temp.
5. Press **SET** to return to the default screen.

Putting the meat probe into the cooking meat will give an actual temp. reading. The display will flash red and the alarm will sound (if set to do so) when the actual temp. reaches the set temp. The alarm is silenced by pressing any button on the thermometer.

Note: The meat probe is calibrated specifically for use at temperatures between 130°F and 180°F.

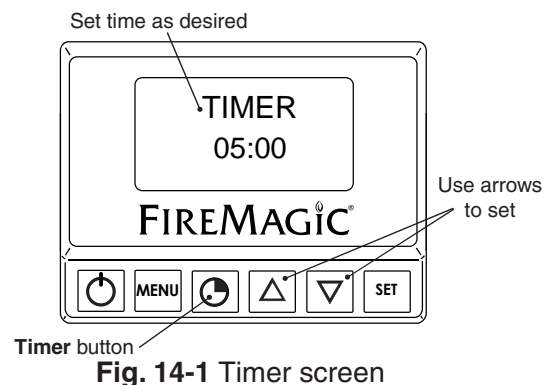

Fig. 14-1 Timer screen

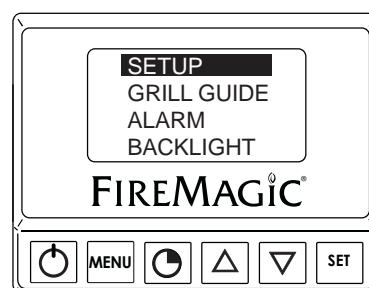

Fig. 14-2 Menu screen



Fig. 14-3 Meat probe

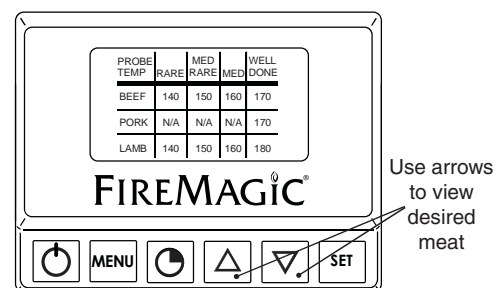

Fig. 14-4 Grill Guide screen

DIGITAL THERMOMETER (cont.)

Setting the Alarm

The alarm can be individually set (ON or OFF) for the meat probe and oven temp. The default setting has the alarm OFF for the meat probe and oven temp. The alarm always alerts for the TIMER.

1. Under the menu screen select ALARM. Press **SET**.
2. Use the up/down arrow to select the desired alarm, and press the power button to turn the alarm ON/OFF.
3. Press **SET** to return to the menu screen.

Setting the Thermometer Backlight

The default color for the thermometer backlight is blue. The color may be changed as desired by turning the three base colors ON/OFF. Various combinations will result in different colors.

1. Under the menu screen select BACKLIGHT. Press **SET**.
2. Use the up/down arrow to select the desired color, and press the power button to turn the color ON/OFF.
3. Press **SET** to return to the menu screen. The new color will be displayed.

Note: Turning all colors OFF will result in no backlight.

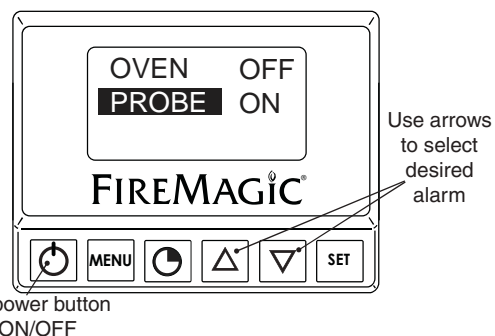

Fig. 15-1 Alarm screen

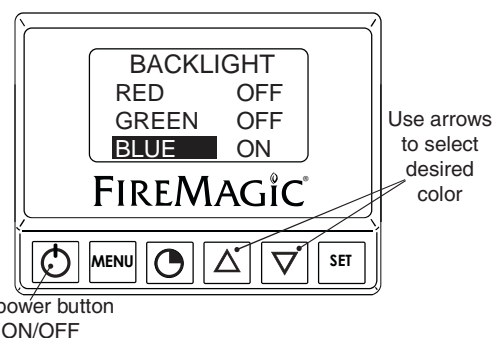

Fig. 15-2 Backlight screen

OPERATION SUMMARY

The operation section provides basic guidelines for lighting and using your smoker. Cooking temperatures, times, and methods may vary depending on personal preference, weather conditions, etc.

The thermometer provides an overall, average temperature reading. The temp. will slightly vary amongst the interior of the smoker (top, center, bottom, sides, rear).

ADDING ADDITIONAL CHARCOAL / WOOD CHIPS DURING COOKING

It is recommended that all charcoal and wood chips are loaded into the chambers, as instructed in the PRE-HEATING, SMOKING START UP & LOADING section. However, if additional amounts are required during cooking; **FIRST COMPLETELY CLOSE THE AIR SHUTTERS**, then add carefully and with proper hand protection. Re-open the air shutters as needed after done loading.

CAUTION: OPENING THE FIREBOX DOOR WILL INTRODUCE A FLOW OF OXYGEN TO THE CHARCOAL AND MAY CAUSE A FLARE-UP! When opening the door; open slowly to carefully allow heat and steam to escape. Use caution and keep hands, face, and body at a safe distance.

OVERHEATING

Should the smoker temperature rise higher than the desired cooking temperature; please follow these tips to slowly reduce:

- Completely close the two ash door air shutters. (If the ash door air shutters are left closed for too long a period; the fire may completely turn out.)
- Completely close the chimneys.
- Fully open the front door air shutter.

If the smoker is high above the cooking temperature and a quicker temperature reduction is necessary;

- Crack open the door by setting the latches on the second notch, as seen in Fig. 16-2.

Important: Use caution when handling as surfaces may be HOT.



Fig. 16-1



Fig. 16-2

POST-OPERATION

Once the cook is done and the food has been removed, please follow these post-operation instructions. DO NOT LEAVE THE UNIT UNATTENDED WHEN IN USE.

1. Open the air shutters and chimneys completely.
2. Allow to burn completely. This will allow the charcoal and wood chips to be safely consumed.
3. Once the coals have completely burned out, allow sufficient time for the coals and the smoker to completely cool.
4. Remove all of the ashes from the ash compartment. To avoid the possibility of burns, wear (dry) protective gloves. The charcoal and wood chip grids may be removed to assist in removing all of the ash. The ash tray may also be removed. Properly discard of the ashes.
5. Clean your smoker thoroughly as instructed in the SERVICING AND CLEANING section.
6. Store the unit out of reach of children, in a well ventilated, dry place.

SMOKING TIMES AND TEMPERATURES

The below chart is provided for suggested smoking times and temperatures. The cook times are approximations and may vary. Use the digital thermometer (and meat probe) to monitor the temperatures.

Meat type	Smoking Temp.	Approximate Time to Complete	Finished Meat Internal Temp.
Brisket (Sliced)	225°F	1.5 hours/pound	180°F
Brisket (Pulled)	225°F	1.5 hours/pound	195°F
Pork Butt (Sliced)	225°F	1.5 hours/pound	175°F
Pork Butt (Pulled)	225°F	1.5 hours/pound	190-205°F
Whole Chicken	250°F	4 hours (approx.)	167°F
Chicken Thighs	250°F	1.5 hours	167°F
Chicken Quarters	250°F	3 hours	167°F
Whole Turkey 12#	240°F	6.5 hours	170°F
Turkey Leg	250°F	4 hours	165°F
Meat Loaf	250 - 300°F	3 hours	160°F
Spare Ribs	225 - 240°F	6 hours	172°F
Baby Back Ribs	225 - 240°F	5 hours	168°F
Smoked Corn	225°F	1.5 - 2 hours	N/A
Smoked Potatoes	225°F	2 - 2.5 hours	N/A

SERVICING AND CLEANING

ALWAYS ALLOW THE SMOKER TO COMPLETELY COOL BEFORE ANY SERVICING / CLEANING. DO NOT SPRAY ANY CLEANER OR LIQUIDS ON THE APPLIANCE WHEN HOT.

Any components removed during servicing/cleaning must be reinstalled, as previously instructed in this manual, prior to future operation. CONTACT YOUR DEALER FOR REPLACEMENT PARTS.

It is recommended that the smoker be cleaned after each use.

INTERIOR CLEANING

1. Ensure the ash compartment is completely cleaned out of all coals and ashes.
2. Wipe down the charcoal grid, wood chip grid, and ash tray with a damp cloth.
3. Remove the cooking grids, drip collector, and drip tray. **Properly dispose of the drip tray grease.** Wash all items with warm, soapy water. Rinse well and dry.
4. Wipe down the entire interior of the smoker with a damp cloth to remove any loose food particles. Dry thoroughly.
5. Wipe the door seal with a mild degreaser to remove any grease. This will help maintain a proper seal.

STAINLESS STEEL CARE

Stainless steel surfaces when exposed to temperatures produced by the cooking process will change color. The stainless steel will change color from silver to brown and blue. This can be removed by using Fire Magic Stainless Steel Cleaner (3581-1).

Clean your smoker by first using Fire Magic Barbecue and Grill Cleaner (part #3580-1) to remove grease and dirt. Always wipe with the grain (See Fig. 18-1). Next, use Fire Magic Stainless Steel Cleaner (3581-1) to restore the stainless steel color. Finish by wiping your unit down using Fire Magic Polish Wipes (3586-1).

If your smoker is located in a seaside (salt air) or poolside (chlorine) location, it will be more susceptible to corrosion and must be maintained/cleaned more frequently. Do not store chemicals (such as chlorine or fertilizer) near your unit.

Due to the nature of stainless steel, surface iron oxide deposits may appear. Do not be alarmed – these deposits are removable with stainless-steel cleaner through prompt and periodic maintenance. If not attended to promptly, permanent pitting may occur.

REPLACING THERMOMETER BATTERIES

Remove the thermometer from its compartment by slightly sliding it to the left, then lifting the right side outward until it clears the compartment. Locate the battery holder attached to the back of the thermometer, and replace the 2 AA batteries. See Fig. 18-2 and Fig. 18-3.



Fig. 18-1

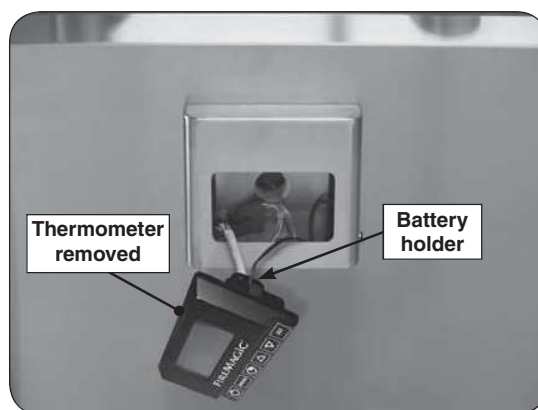

Fig. 18-2

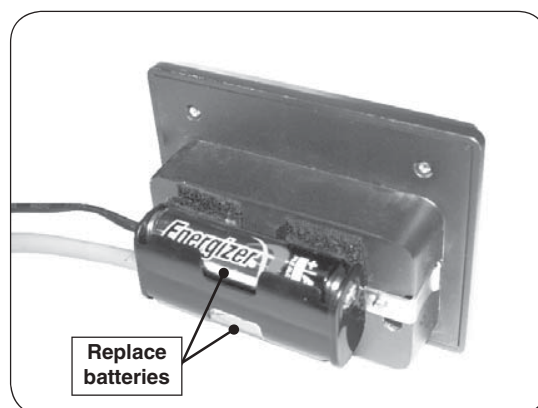

Fig. 18-2

ACCESSORIES

ACCESSORY DRAWER (optional)

The smoker may be ordered equipped with a base drawer, or retro-fitted with the drawer (model #24-SMB) at a later time. The drawer provides for convenient storage and is designed to be installed directly below the smoker. Reference Fig. 19-1 for a base drawer installed.

To remove the drawer; pull it completely out. Release the drawer from the drawer slides by pressing the black lever down on the right side, and up on the left side.

To re-attach the drawer; extend the drawer slides completely and align the drawer into the slides, pushing the drawer closed. Open the drawer to verify that it has locked in place.

Contact your local dealer for ordering information.



Fig. 19-1

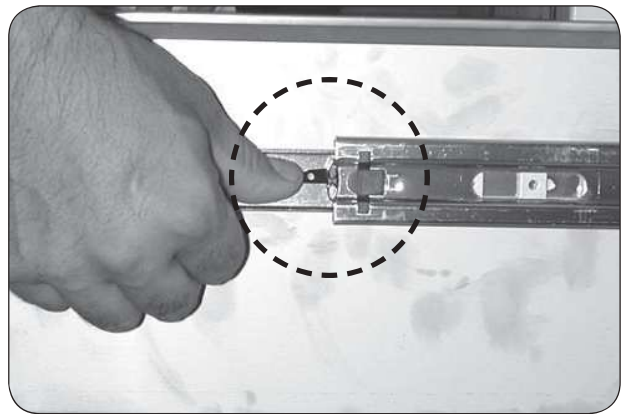

Fig. 19-2

NOTES PAGE

Please use this page to record any information about your unit that you may want to have at hand.

TROUBLESHOOTING

If you have trouble with this smoker, please use this list to identify the problem. By trying one or more of the solutions to the possible cause, you should be able to solve the problem. If this list does not cover your present problem, or if you have other difficulties with the smoker, please contact your local Fire Magic dealer or visit our web site at www.rhpeterson.com.

PROBLEM	POSSIBLE CAUSE	CORRECTION
Thermometer does not turn on or is malfunctioning	1. Low or dead batteries	1. Replace batteries.
Smoker temperature higher than desired cooking temperature	1. Overheating	1. Follow the steps in the OVERHEATING section of this manual to slowly reduce temperature.
Smoker temperature lower than desired cooking temperature	1. Under heating	<p>1a. Ensure ash door air shutters are fully open. ALLOW SUFFICIENT TIME FOR TEMPERATURE TO RISE.</p> <p>If 1a. does not resolve the issue;</p> <p>1b. COMPLETELY CLOSE THE ASH DOOR AIR SHUTTERS. Then, carefully add additional charcoal to the charcoal chamber. Be sure to close the charcoal door when done. Re-open the air shutters as needed after done loading and the charcoal door is closed.</p> <p style="text-align: center;">NEVER ADD LIGHTER FLUID.</p>

WARRANTY

TEN-YEAR WARRANTY - Fire Magic® stainless steel cooking grids are warranted for ten (10) years from the date of purchase of your Fire Magic® charcoal grill/smoker.

FIVE-YEAR WARRANTY - Fire Magic® stainless steel charcoal grills/smokers (excluding the charcoal pan, grid, wood pellet screen, thermometer, and ash tray) are warranted for five (5) years from the date of purchase of your Fire Magic® charcoal grill/smoker.

ONE-YEAR WARRANTY - Fire Magic® charcoal pan, grid, wood pellet screen, thermometer, and ash trays are each warranted for one (1) year from the date of purchase of your Fire Magic® charcoal grill/smoker.

PLEASE KEEP A COPY OF YOUR SALES SLIP FOR PROOF OF PURCHASE

This warranty applies to the original purchaser and to single family residential use only. It commences from date of purchase, and is valid only with proof of purchase.

This warranty does not cover parts becoming defective through misuse, accidental damage, electrical damage, improper handling, lack of routine maintenance, storage, and/or installation. Product must be installed (and gas must be connected) as specified in the instructions or operator's manual, by a **qualified professional installer**. Accessories, parts, valves, remotes, etc., when used must be Peterson Co. product.

This warranty **does not** apply to rust, corrosion, oxidation, or discoloration, unless the affected component becomes inoperable. It **does not** cover labor or labor-related charges.

This warranty specifically excludes liability for **indirect, incidental**, or consequential damages. Some states do not allow the exclusion or limitation of incidental or consequential damages, so the above exclusion may not apply to you. This warranty gives you specified legal rights, and you may have other rights that may vary from state to state.

For additional information regarding this warranty, or to place a warranty claim, contact the R.H. Peterson dealer where the product was purchased.

**TO REGISTER YOUR PRODUCT ONLINE GO TO: WWW.RHPETERSON.COM,
AND CLICK ON PRODUCT REGISTRATION. THANK YOU FOR YOUR PURCHASE.**

Quality Check	Date: _____
Model#: _____	Serial#: _____
Inspector: _____	Workmanship Inspection: _____